

FALCON LIFTS A/S

Tolderlundsvej 106
DK-5000 Odense C
Tel: +45 66 13 11 00

falconlifts.com



FALCON 430 *Vario*

Reach diagram - Optimized position

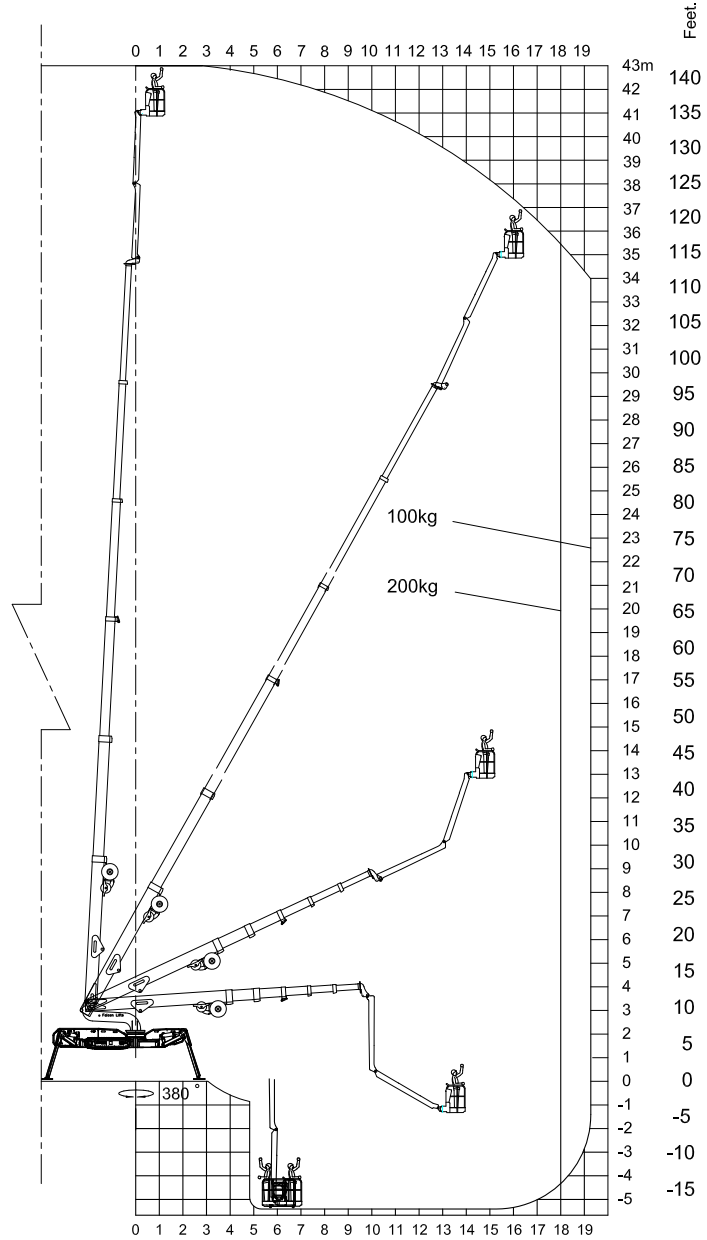
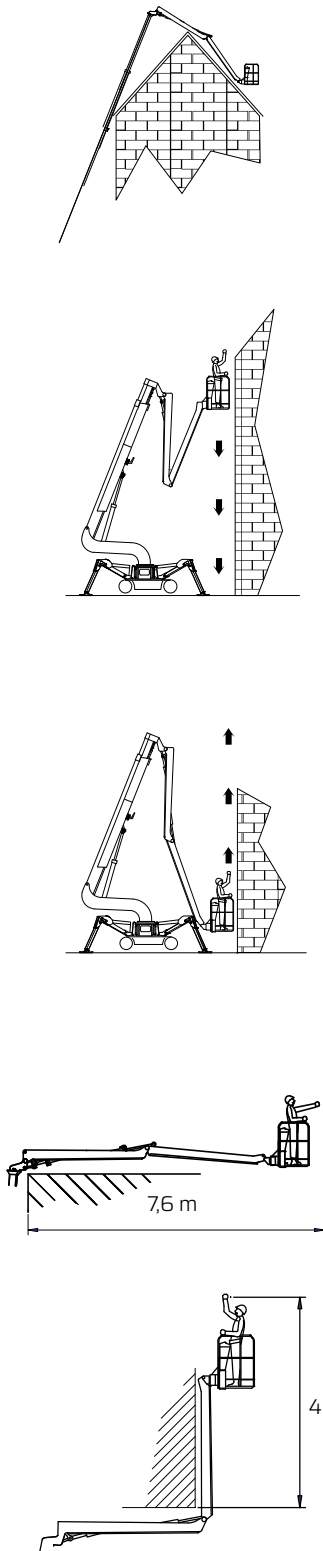

Reach with outriggers in different positions

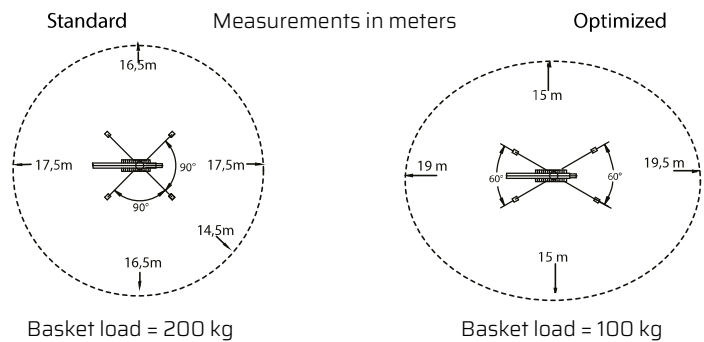

All measurements are intended as guide. Choise of equipment may change the mentioned measurements

FALCON 430 *Vario*

Outer measurements

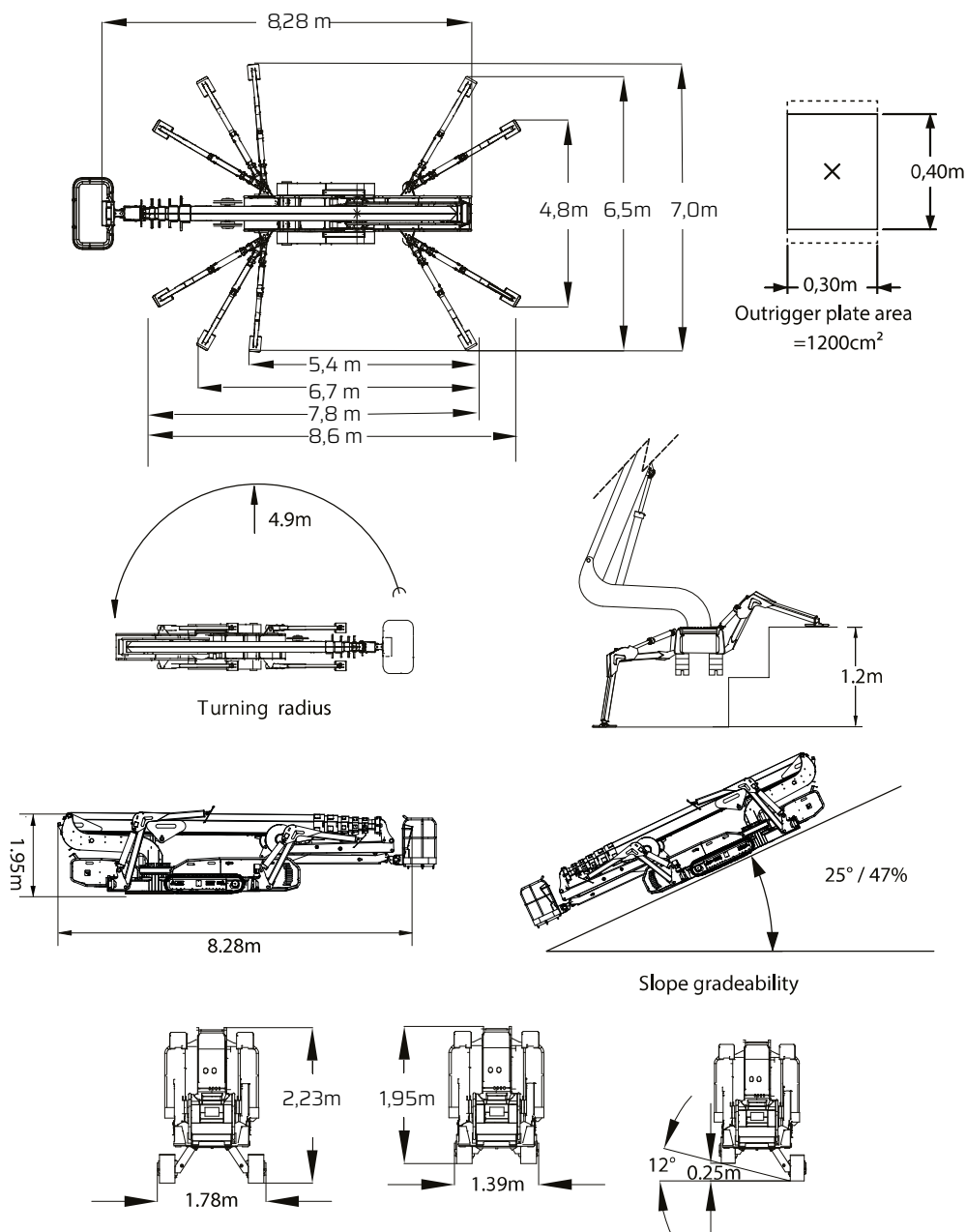
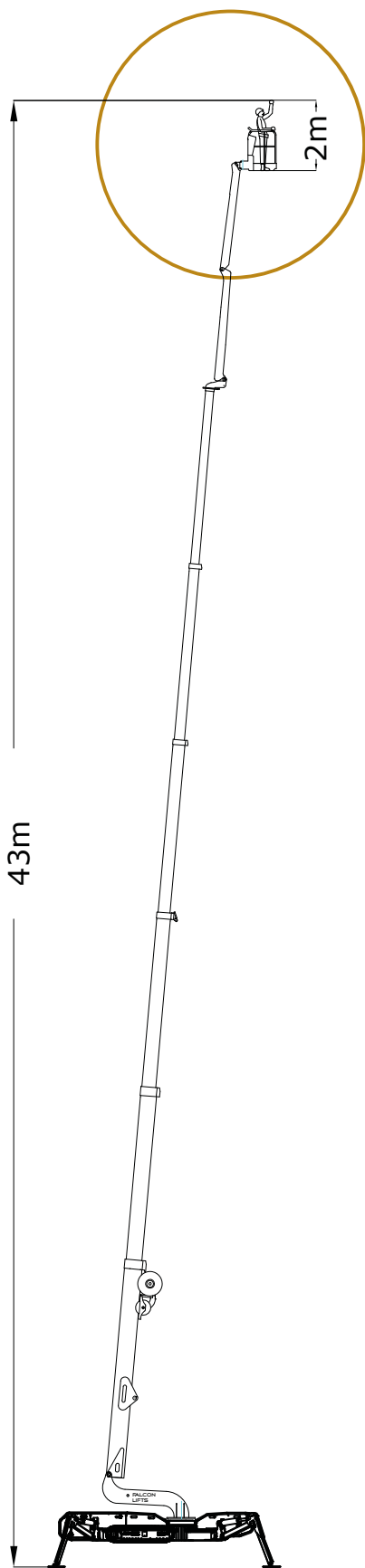

Additional info:

Weight and ground pressure:

Weight with standard equipment	8340	kg.
Surface pressure under crawlers (soft surface)	0,93	kg/cm ²
Surface pressure under crawlers (hard surface)	1,86	kg/cm ²
Max. ground pressure under 1 outrigger plate	3,25	kg/cm ²